

GTMR 346 B

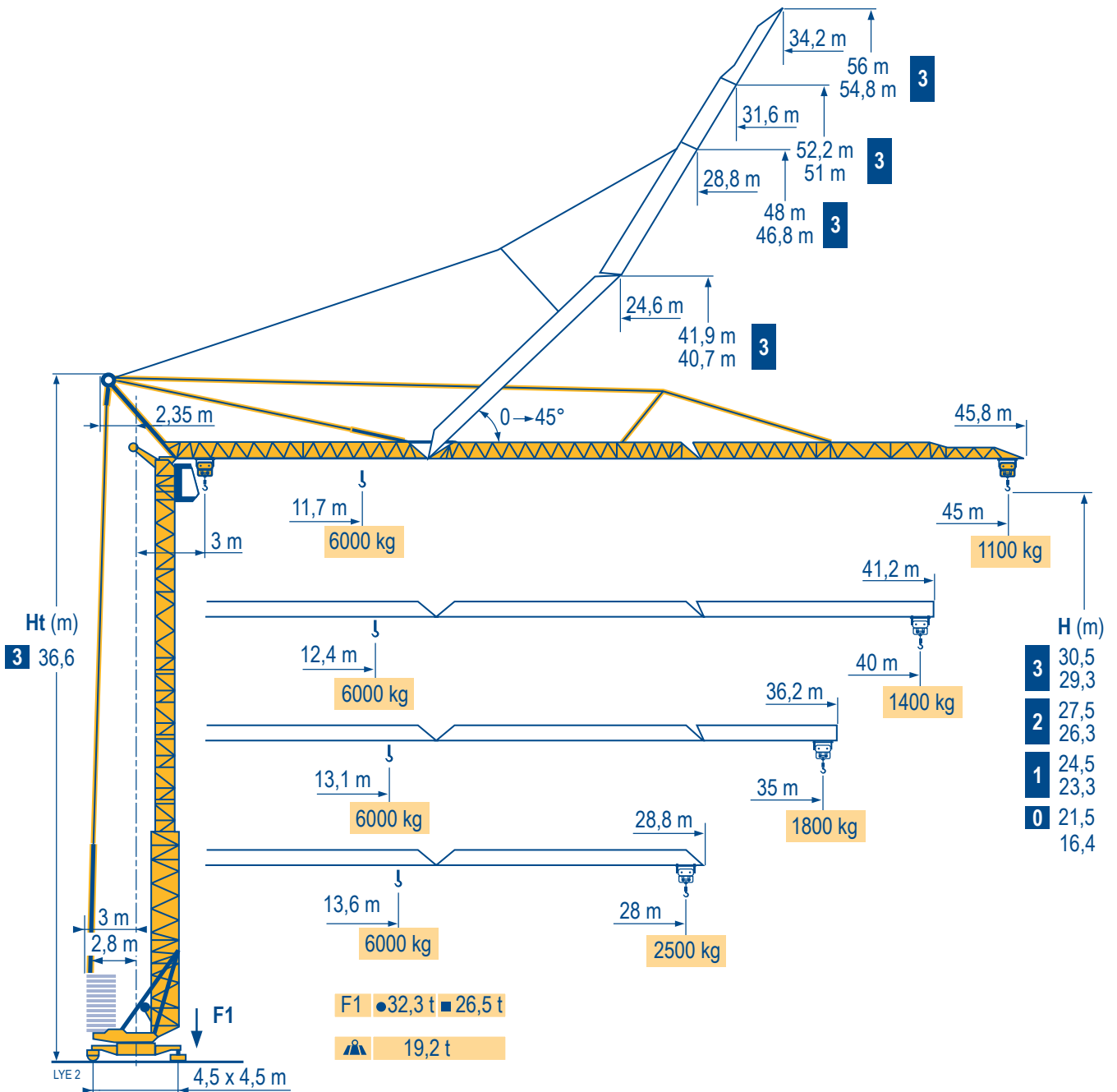

Courbes de charges Lastkurven Load diagrams Curvas de cargas Curve di carico Curva de cargas	45 m	3 ▶	11,7	13	15	17	20	23	25	27	30	33	35	37	40	43	45	m
	▶		6000	5265	4400	3770	3090	2600	2345	2130	1865	1655	1535	1430	1290	1170	1100	kg
	40 m	3 ▶	12,4	13	15	17	20	23	25	27	30	33	35	37	40	m		
	▶		6000	5650	4730	4055	3325	2800	2530	2300	2020	1790	1660	1550	1400	kg		
	LVE 1	35 m	3 ▶	13,1	15	17	20	23	25	27	30	33	35	m				
	▶		6000	5080	4360	3580	3020	2725	2480	2180	1940	1800	kg					
		28 m	3 ▶	13,6	15	17	20	23	25	27	28	m						
	▶		6000	5330	4580	3760	3175	2870	2615	2500	kg							

Flèche relevée
Ausleger in Steilstellung
Luffing jib
Flecha izada
Braccio impennato
Lança inclinada

LVE 1

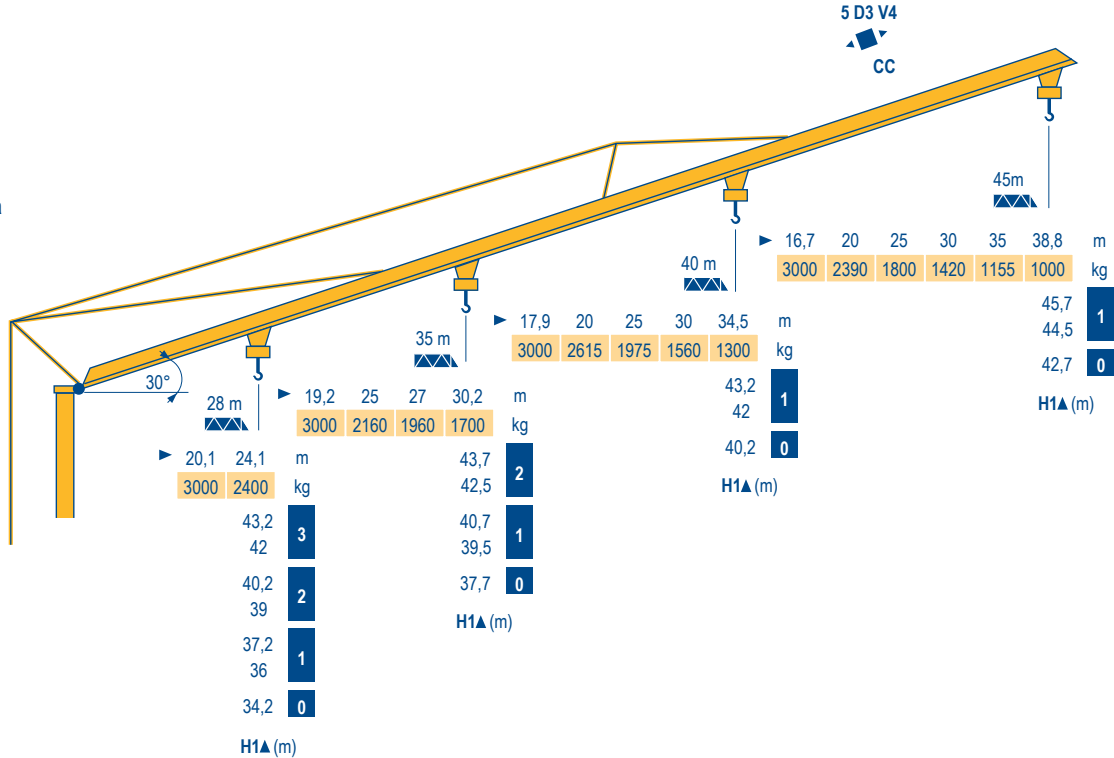













GTMR 346 B



CC	F Chariot distributeur et courbes de charges Réactions en service Réactions hors service A vide sans lest (ni train de transport) avec flèche et hauteur maximum.	D Verfahrbare Laufkatze und Lastkurven Reaktionskräfte in Betrieb Reaktionskräfte außer Betrieb Ohne Last, Ballast (und Transportachse), mit Maximalausleger und Maximalhöhe.	GB Traversing trolley and load diagrams Reactions in service Reactions out of service Without load, ballast (or transport axles), with maximum jib and maximum height.	E Carro distribuidor y curvas de cargas Reacciones en servicio Reacciones fuera de servicio Sin carga, sin lastre, (ni tren de transporte), flecha y altura máxima.	I Carrellino distributore e curve di carico Reazioni in servizio Reazioni fuori servizio A vuoto, senza zavorra (ne assali di trasporto) con braccio massimo e altezza massima.	P Carro distribuidor e curva de cargas Reacções em serviço Reacções fora de serviço Sem carga (nem trem de transporte)- sem lastro com lança e altura máximas.
-----------	--	--	---	--	--	---

Mécanismes
Antriebe
Mechanisms
Mecanismos
Meccanismi
Mecanismos

LVE 2

									ch - PS hp	kW
										
	20 LVF 15	m/min	5,5	27,5	55	2,7	13,7	27,5	20	15
		Kg	3000	3000	1500	6000	6000	3000		
	5 D3 V4	m/min	15 - 30 - 58						5,5	4
	RCV 51	tr/min U/min rpm	0 → 0,8						6	4,4
 R ≥ 8 m	TDV 324	m/min	25						2 x 4	2 x 3
	TB 124	m/min	25						2 x 4	2 x 3
CEI 38  IEC 38			KVA							
400 V (+6% -10%) 50 Hz			30 kVA							

Montage
Montage
Erection
Montaje
Montaggio
Montagem

LVE 1

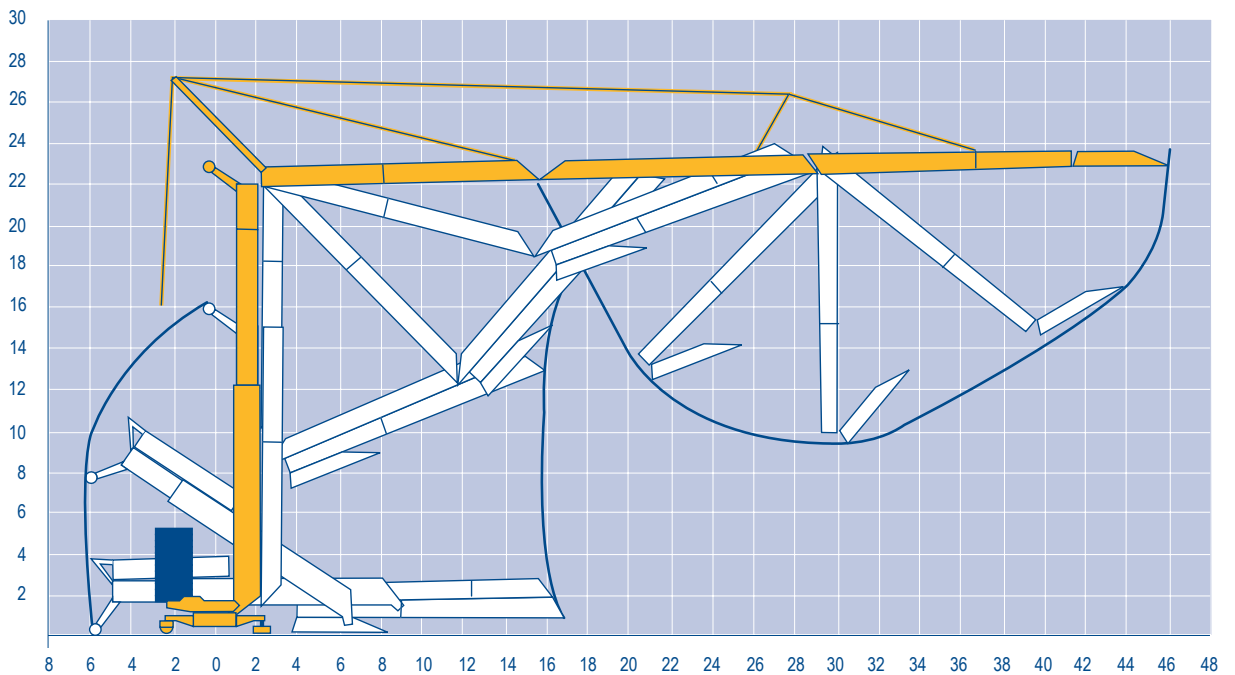

GTMR 346 B

POTAIN 



F
Leverage
Distribution
Orientation
Translation

D
Heben
Katzfahren
Schwenken
Kranfahren

GB
Hoisting
Trolleying
Slewing
Travelling

E
Elevación
Distribución
Orientación
Traslación

I
Sollevamento
Distribuzione
Rotazione
Traslazione

P
Elevação
Distribuição
Rotação
Translação

Transport
 Transport
 Transport
 Transporte
 Trasporto
 Transporte

LYE 1

DJ126M/S215M

15A/25A

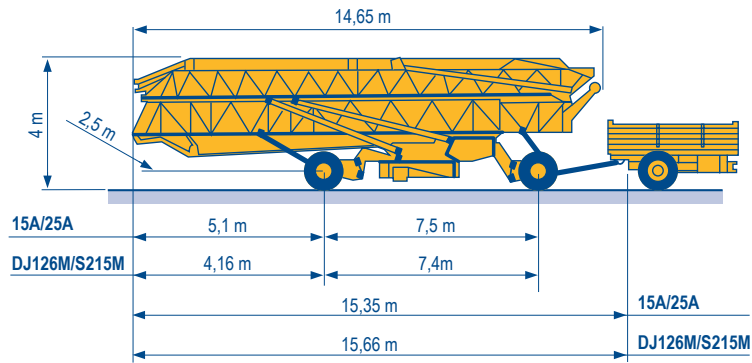

S4/S215M

S5B/J215M

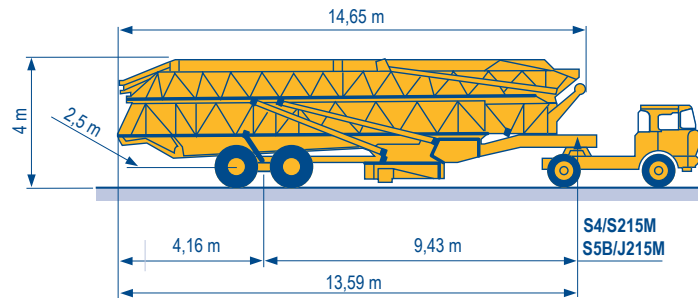

Document commercial non contractuel. Pour toute information technique se référer à la notice correspondante.

Unverbindliches Vertriebsdokument. Für technische Informationen, siehe die entsprechenden Anweisungen.

This commercial document is not legally binding. For any technical information, please refer to the corresponding instructions.

Documento comercial no contractual. Para cualquier información técnica, ver la noticia correspondiente.

Documento commerciale non vincolante. Per tutte le informazioni tecniche fare riferimento al catalogo istruzioni.

Documento comercial não contratual. Para qualquer informação técnica complementar consultar as respectivas instruções.

Manitowoc
 Crane CARE

POTAIN

Manitowoc Crane Group



18, rue de Charbonnières - B.P.173
 69132 ECULLY Cedex - France

Tél. : +33 (0) 4 72 18 20 20
 Fax. : +33 (0) 4 72 18 20 00
 www.manitowoccrane.com

Americas

Tel : +1 888 479 7278
 Tel : +1 717 593 2000

Europe - Middle East - Africa

Tel : +33 (0) 4 72 81 50 00
 Tel : +44 (0) 191 522 2000

Asia - Pacific

Tel : +65 6264 1188
 Fax : +65 6862 4040

www.manitowoccrane.com

GTM R 346 B

Code G-91985-34_Réf. 2003 48 LYE 4

Copyright.Reproduction interdite © POTAIN 2003

Réalisation Secoc